

Inorganic Nomenclature

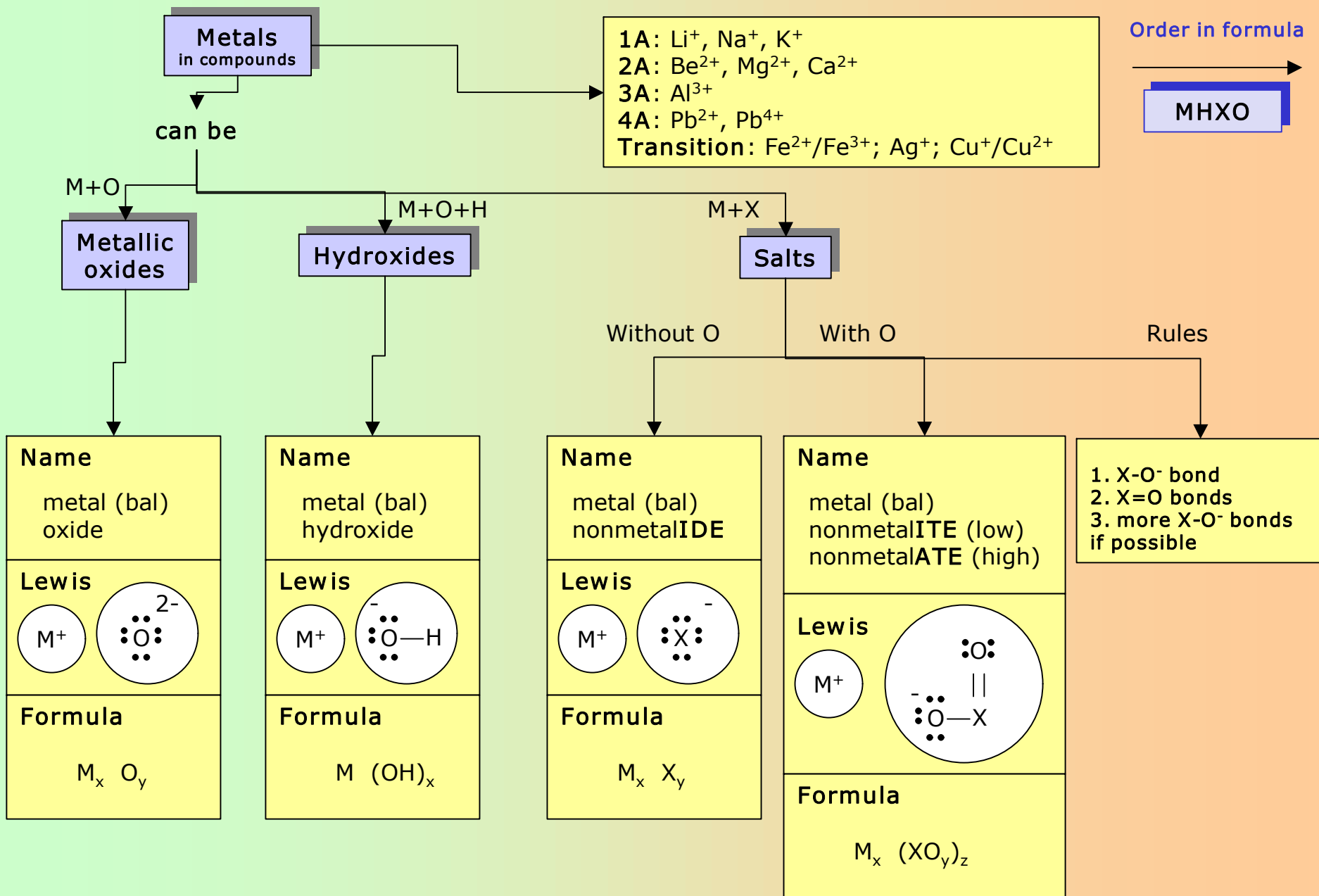

Inorganic Nomenclature

**Nonmetal
in compounds**

7A: F (1) / Cl and Br (1,3,5,7)
6A: O (2) / S (2,4,6)
5A: N and P (3,5)
4A: C(2,4)

Order in formula

MHXO

can be

X+O

X+H

M+X

**Nonmetallic
oxides**

Acids

Salts

Without O
Val low

With O

Rules

Without O
Val low

With O

Name

nonmetal (bal)
oxide

Lewis

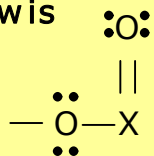

Formula

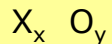

Name

hydro
nonmetalIC
acid

Lewis

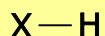

Formula



Name

[HYPO]nonmetalOUS (low)
[PER]nonmetalIC (high)

Lewis

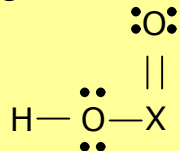

Formula

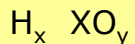

1. X-O-H bond

2. X=O bonds

3. more X-O-H
bonds when
possible

Name

metal (bal)
nonmetalIDE

Lewis

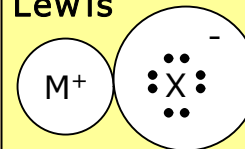

Formula

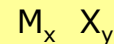

Name

metal (bal)
nonmetalITE (low)
nonmetalATE (high)

Lewis

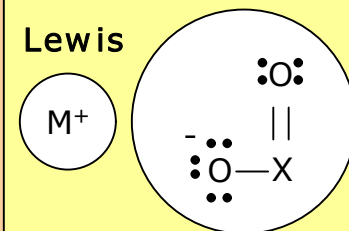

Formula

